

100MS22ACMA1STD

Aliases (A902GP100V220A)

MS/A902, Aluminum Electrolytic, 100 uF, -0/+25%, 220 VAC, -20/+60°C

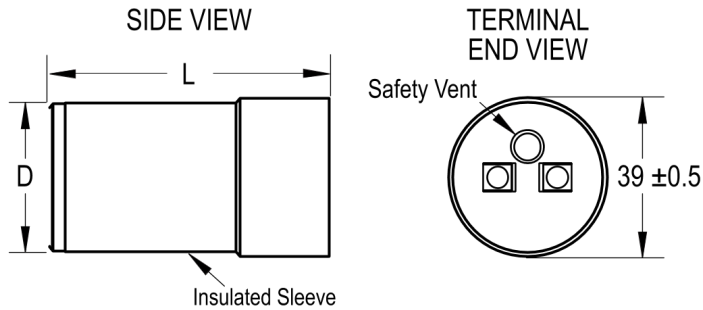

Click [here](#) for the 3D model.

Dimensions

D	38mm +/-0.5mm
L	116mm MAX

Packaging Specifications

Packaging	Bulk, Bag
-----------	-----------

General Information

Series	MS/A902
Dielectric	Aluminum Electrolytic
Description	Motor Start Aluminum Electrolytic
RoHS	Yes
Lead	Quick Connect
AEC-Q200	No
Halogen Free	Yes
Shelf Life	156 Weeks

Specifications

Capacitance	100 uF
Capacitance Tolerance	-0/+25%
Voltage AC	220 VAC
Temperature Range	-20/+60°C
Rated Temperature	60°C
Life	500 Hrs

Statements of suitability for certain applications are based on our knowledge of typical operating conditions for such applications, but are not intended to constitute - and we specifically disclaim - any warranty concerning suitability for a specific customer application or use. This information is intended for use only by customers who have the requisite experience and capability to determine the correct products for their application. Any technical advice inferred from this information or otherwise provided by us with reference to the use of our products is given gratis, and we assume no obligation or liability for the advice given or results obtained.