

F5ABC4120CKE6M

Aliases (5ABC4120CKE6M)

F5A, Film, Metallized Polyester, Varistor/Capacitor, 1.2 uF, 20%, 18 VDC, 100°C, 5mm

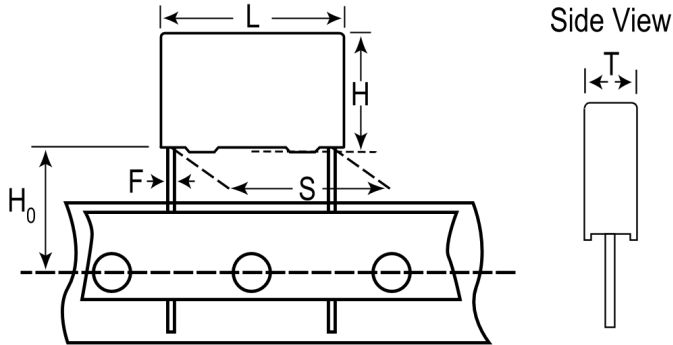

Click [here](#) for the 3D model.

Dimensions

L	7.5mm MAX
H	10.1mm MAX
T	5.1mm MAX
S	5mm +0.6/-0.1mm
H0	18.5mm +/-0.5mm
F	0.6mm +/-0.05mm

Packaging Specifications

Packaging	T&R
Packaging Quantity	1200

General Information

Series	F5A
Dielectric	Metallized Polyester
Style	Radial
Features	EMI-RFI suppressors for DC motors
RoHS	Yes
Termination	Tinned Wire
Lead	Wire Leads
Qualifications	AEC-Q200
AEC-Q200	Yes
Miscellaneous	The Rated Voltage Decreases 2%/C Between +100C And +125C. Varistor= 27 VDC.

Specifications

Capacitance	1.2 uF
Capacitance Tolerance	20%
Voltage DC	18 VDC, 9 VDC (125C)
Temperature Range	-55/+125°C
Rated Temperature	100°C
Dissipation Factor	1% 1kHz