

CDR32BP220BFUP

Aliases (C1206N220F1GPL, CDR32BP220BFZP, CDR32BP220BFWP)

SMD Mil PRF55681, Ceramic, 22 pF, 1%, 100 VDC, BP, Ceramic Chips, MIL PRF 55681 Established Reliability, P (0.1%/1000 Hrs), 1206

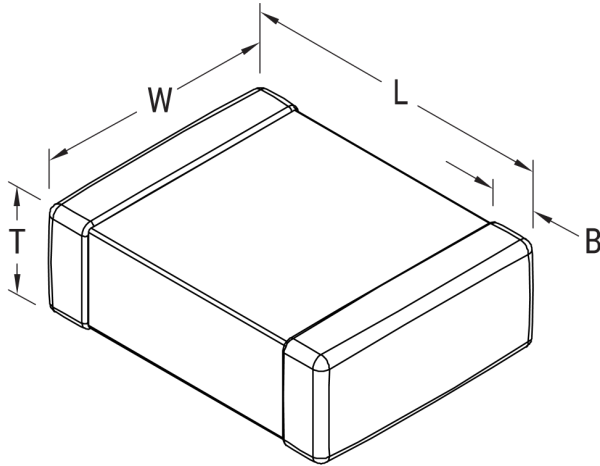

Click [here](#) for the 3D model.

Dimensions

Chip Size	1206
L	2mm +/-0.2mm
W	1.25mm +/-0.2mm
T	1.3mm MAX
B	0.5mm +/-0.2mm

Packaging Specifications

Packaging	Bulk, Bag
Packaging Quantity	1

General Information

Series	SMD Mil PRF55681
Style	SMD Chip
Description	Ceramic Chips, MIL PRF 55681 Established Reliability
RoHS	No
Prop 65	⚠ WARNING: Cancer and reproductive harm - http://www.p65warnings.ca.gov .
Termination	Lead (SnPb)
Failure Rate	P (0.1%/1000 Hrs)
Testing and Reliability	MIL-PRF-55681
Qualifications	MIL-PRF-55681
AEC-Q200	No
Shelf Life	78 Weeks
MSL	1

Specifications

Capacitance	22 pF
Capacitance Tolerance	1%
Voltage DC	100 VDC
Dielectric Withstanding Voltage	250 VDC
Temperature Range	-55/+125°C
Temperature Coefficient	BP
Dissipation Factor	0.15%
Insulation Resistance	100 GOhms