

ESD-R-38SR-P

Aliases (UECESDR38SRP00)

KEMET, ESD-R-SR, EMI Cores, Noise Suppression

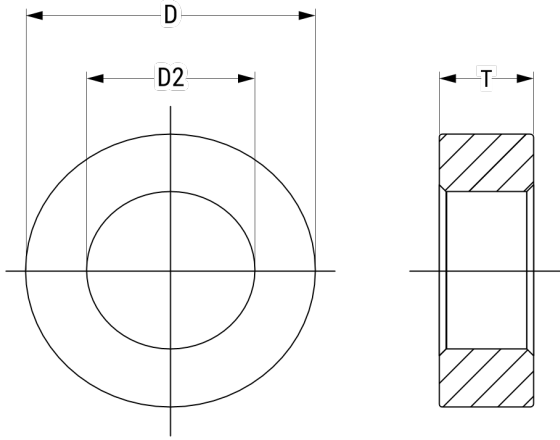

Click [here](#) for the 3D model.

Dimensions

D	39.5mm MAX
D2	18mm MIN
T	14mm MAX

Packaging Specifications

Packaging	Tray, Box
Packaging Quantity	200
Typical Component Weight	53.3 g

General Information

Series	ESD-R-SR
Style	Round - Toroidal
Cable Type	Round Cable
Description	EMI Core Solid, Large-Size Ring Type, For Round Cables, Coated Type
Features	High Impedance, Effectively Suppresses Radiation at 150 kHz, Low Frequency Noise
RoHS	Yes
Qualifications	UL94 V-2
Case Color	Gray
Materials	Mn-Zn

Specifications

Temperature Range	-25/+85°C
Effective Frequency	10 MHz (AM Band Range)