

F5DDF3470CKB2M

Aliases (5DDF3470CKB2M)

F5D, Film, Metallized Polyester, Capacitor/Capacitor, 0.47 uF, 20%, 63 VDC, 100°C, 10mm

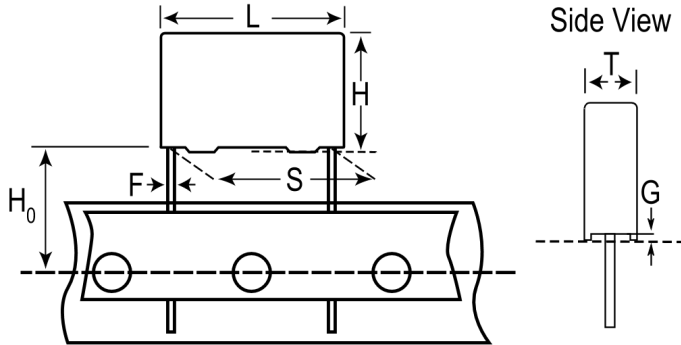

General Information

Series	F5D
Dielectric	Metallized Polyester
Style	Radial
Features	EMI-RFI suppressors for DC motors
RoHS	Yes
Termination	Tinned Wire
Lead	Wire Leads
Qualifications	AEC-Q200
AEC-Q200	Yes
Miscellaneous	The Rated Voltage Decreases 2%/C Between +100C And +125C. CeramicCapValue= 0.0047 uF.

Specifications

Capacitance	0.47 uF
Capacitance Tolerance	20%
Voltage DC	63 VDC, 32 VDC (125C)
Temperature Range	-55/+125°C
Rated Temperature	100°C
Dissipation Factor	2.5% 1kHz

Click [here](#) for the 3D model.

Dimensions

L	13.35mm MAX
H	11.1mm MAX
T	5.2mm MAX
S	10mm +0.6/-0.1mm
H0	18.5mm +/-0.5mm
F	0.75mm +/-0.05mm
G	0.5mm NOM

Packaging Specifications

Packaging	T&R, Large
Packaging Quantity	1250

Statements of suitability for certain applications are based on our knowledge of typical operating conditions for such applications, but are not intended to constitute - and we specifically disclaim - any warranty concerning suitability for a specific customer application or use. This information is intended for use only by customers who have the requisite experience and capability to determine the correct products for their application. Any technical advice inferred from this information or otherwise provided by us with reference to the use of our products is given gratis, and we assume no obligation or liability for the advice given or results obtained.