

FLLE2025APMD

Aliases (LLE2025APMD)

KEMET, FLLE2-P, EMI/RFI Filters, Noise Suppression, 300 VAC, 300 V, 25 A, 65x50x40mm

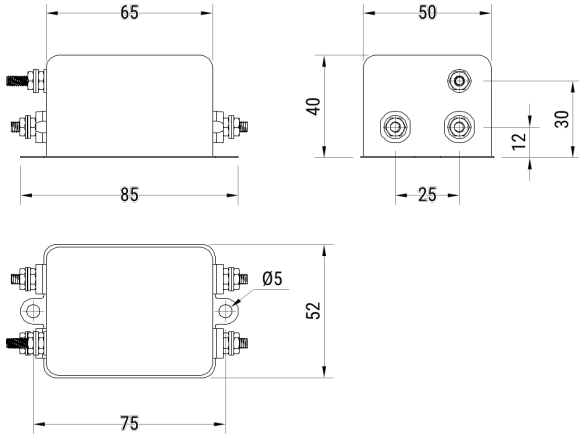

Click [here](#) for the 3D model.

Dimensions

L	65mm MIN
W	50mm MIN
H	40mm MIN
Lead	Wire Leads

Packaging Specifications

Packaging	Bulk
Packaging Quantity	1
Typical Component Weight	290 g

General Information

Series	FLLE2-P
Style	Chassis Mount
Description	Single Phase, Chassis Mount Filters
Features	Single Phase, Medical
Phase	Single-phase
RoHS	Yes
Qualifications	IEC/EN 60939, UL, CSA
Lead	Wire Leads
Terminal Type	Wire

Specifications

Voltage AC	300 VAC
Voltage DC	300 VDC
Rated Frequency	50-60 Hz
Rated Current	25 A
Ripple Current	25 A
Rated Temperature	40°C
Temperature Range	-25/+100°C
Climate Category	25/100/21
Leakage Current	0.37 mA (MAX)
Test Voltage DC (P/N to E)	2250 VDC
Test Voltage DC (P to N)	1300 VDC