

MMK5333J50J01L16.5TA18

Aliases (F601JF333J050R, MMK5333J50J01L16,5TA18)

Not for New Design • Recommended Replacement Series R60

MMK/F601, Film, Metallized Polyester, General Purpose, 0.033 uF, 5%, 50 VDC, 85°C, 5mm

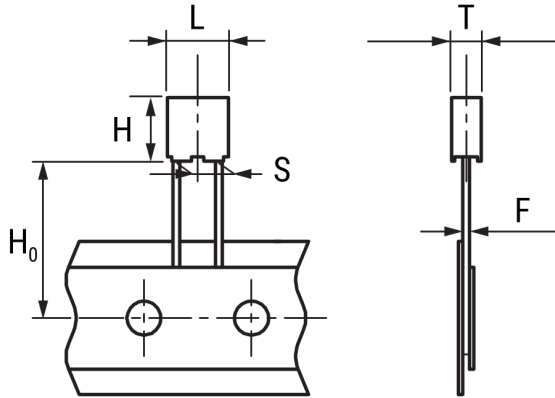

Click [here](#) for the 3D model.

Dimensions

L	7.2mm MAX
H	6.5mm MAX
T	2.5mm MAX
S	5mm +0.6/-0.1mm
H0	16mm NOM
F	0.5mm NOM

Packaging Specifications

Packaging	Ammo, 330x330x50mm, Box
Packaging Quantity	5000

General Information

Series	MMK/F601
Dielectric	Metallized Polyester
Style	Radial
Features	DC Multipurpose Applications
RoHS	Yes
Lead	Wire Leads
AEC-Q200	No
Typical Component Weight	0.238 g
Notes	Not for new design - the replacement series is: R60.

Specifications

Capacitance	0.033 uF
Capacitance Tolerance	5%
Voltage AC	30 VAC
Voltage DC	50 VDC, 38.8 VDC (100C)
Temperature Range	-55/+100°C
Rated Temperature	85°C
Dissipation Factor	0.8% 1kHz, 1.2% 10kHz, 2.5% 100kHz
Insulation Resistance	15 GOhms
Max dV/dt	12 V/us
Inductance	6 nH