

OHD3-35B

Aliases (USEO335B000000)

KEMET, OHD, Thermal Reed Switch, Radial Tab, 5C Temperature Accuracy, High Reliability, High-Speed Response, Long Operational Life, Excellent Environmental Durability, High Temperature Accuracy, 35°C, Break

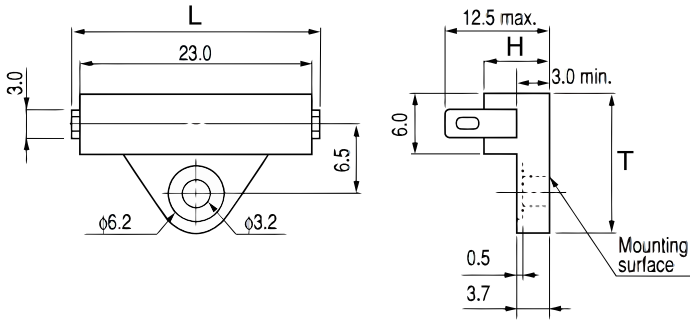

Click [here](#) for the 3D model.

General Information

| | |
|----------------|---|
| Series | OHD |
| Type | Thermal Reed Switch |
| Style | Radial Tab |
| Description | Thermal Guard |
| Features | High Reliability, High-Speed Response, Long Operational Life, Excellent Environmental Durability, High Temperature Accuracy |
| Lead | Tab Leads |
| RoHS | Yes |
| REACH | Yes |
| Qualifications | UL, CSA, TUV |

Dimensions

| | |
|---|----------|
| L | 27mm MAX |
| H | 6mm |
| T | 13.5mm |

Packaging Specifications

| | |
|--------------------------|-----------|
| Packaging | Tray, Box |
| Packaging Quantity | 1000 |
| Typical Component Weight | 2.4 g |

Specifications

| | |
|-----------------------------|---|
| Switching Temperature | 35C +/-5C |
| Temperature Range | -20/+150°C |
| Contact Type | Break |
| Voltage DC | 110 VDC MAX (Opening/Closing), 2500 VAC/1 minute or 3000 VAC/1 second |
| Current | 0.3 Amps AC/DC MAX (Opening/Closing), 0.1 mAmps MIN (1VDC, Opening/Closing) |
| ESR | 150 mOhms MAX (Contact Resistance) |
| Max Opening/Closing Power | 6 (AC/DC) |
| Max Opening/Closing Voltage | 110 (AC/DC) |
| Differential Temperature | 10C Maximum |

Statements of suitability for certain applications are based on our knowledge of typical operating conditions for such applications, but are not intended to constitute - and we specifically disclaim - any warranty concerning suitability for a specific customer application or use. This Information is intended for use only by customers who have the requisite experience and capability to determine the correct products for their application. Any technical advice inferred from this Information or otherwise provided by us with reference to the use of our products is given gratis, and we assume no obligation or liability for the advice given or results obtained.