

R82EC2330DQ50J

Aliases (82EC2330DQ50J)

R82, Film, Metallized Polyester Stacked, Automotive Grade, 0.033 uF, 5%, 100 VDC, 85°C, 5mm

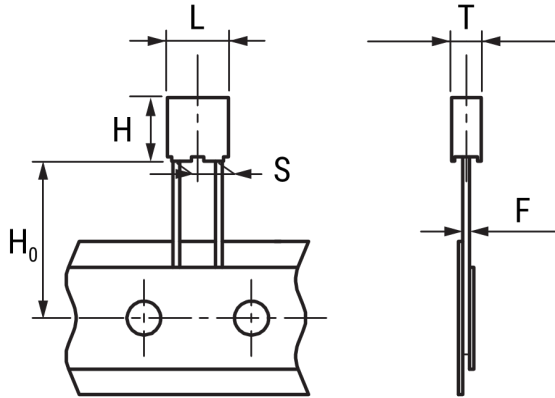

Click [here](#) for the 3D model.

Dimensions

L	7.2mm +0.2mm
H	6.5mm +0.1mm
T	2.5mm +0.1mm
S	5mm +0.6/-0.1mm
H ₀	18.5mm +/-0.5mm
F	0.5mm +/-0.05mm

Packaging Specifications

Packaging	Ammo, 360x340x59mm, Box
Packaging Quantity	3500

General Information

Series	R82
Dielectric	Metallized Polyester Stacked
Style	Radial
Features	Automotive Grade, DC Multipurpose Applications
RoHS	Yes
Lead	Wire Leads
Qualifications	AEC-Q200
AEC-Q200	Yes
Typical Component Weight	0.331 g
Miscellaneous	Above 85C DC And AC Voltage Derating Is 1.25%/C.

Specifications

Capacitance	0.033 uF
Capacitance Tolerance	5%
Voltage DC	100 VDC
Voltage AC	63 VAC
Temperature Range	-55/+105°C
Rated Temperature	85°C
Dissipation Factor	0.8% 1kHz, 1.2% 10kHz, 2.5% 100kHz
Insulation Resistance	15 GOhms
Max dV/dt	200 V/us
Inductance	7 nH

Statements of suitability for certain applications are based on our knowledge of typical operating conditions for such applications, but are not intended to constitute - and we specifically disclaim - any warranty concerning suitability for a specific customer application or use. This information is intended for use only by customers who have the requisite experience and capability to determine the correct products for their application. Any technical advice inferred from this information or otherwise provided by us with reference to the use of our products is given gratis, and we assume no obligation or liability for the advice given or results obtained.