

## SSHB21H-R031580

Aliases (UALSB2R0315800)

KEMET, SSHB21H, AC Line Filters, Dual Mode, 158 mH

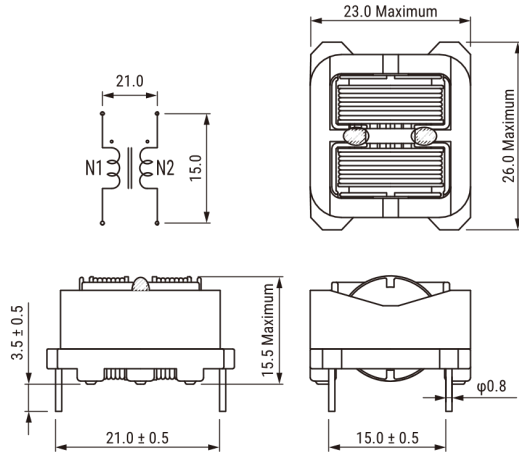

Click [here](#) for the 3D model.

### General Information

Series	SSHB21H
Style	Through-Hole
RoHS	Yes
Notes	Marking: R03 Lot No.
Miscellaneous	Temperature Rise Maximum: 40 K.
Core	Mn-Zn Ferrite

### Specifications

Voltage AC	250 VAC, 320 VAC (IEC60664-1)
Inductance	158 mH (10 kHz)
Current	300 mA
Temperature Range	-40/+120°C
DC Resistance	3.2 Ohms (Per Line)

### Dimensions

L	26mm MAX
T	23mm MAX
H	15.5mm MAX
LL	3.5mm +/-0.5mm
S	21mm +/-0.5mm
S1	15mm NOM
Wire Size	0.2mm

### Packaging Specifications

Packaging	Tray
Packaging Quantity	360
Typical Component Weight	14 g

Statements of suitability for certain applications are based on our knowledge of typical operating conditions for such applications, but are not intended to constitute - and we specifically disclaim - any warranty concerning suitability for a specific customer application or use. This information is intended for use only by customers who have the requisite experience and capability to determine the correct products for their application. Any technical advice inferred from this information or otherwise provided by us with reference to the use of our products is given gratis, and we assume no obligation or liability for the advice given or results obtained.