

C1812C394F3JACTU

Aliases (C1812C394F3JAC7800)

SMD Comm U2J, Ceramic, 0.39 uF, 1%, 25 VDC, U2J, SMD, MLCC, Ultra-Stable, Low Loss, Class I, 1812

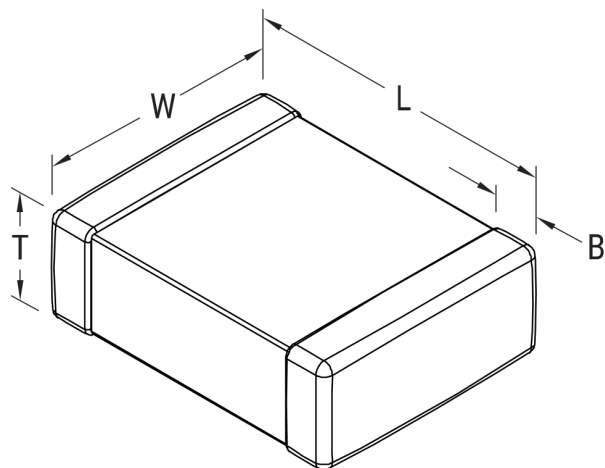

Click [here](#) for the 3D model.

Dimensions

Chip Size	1812
L	4.5mm +/-0.3mm
W	3.2mm +/-0.3mm
T	1.4mm +/-0.15mm
B	0.6mm +/-0.35mm

Packaging Specifications

Packaging	T&R, 180mm, Plastic Tape
Packaging Quantity	1000

General Information

Series	SMD Comm U2J
Style	SMD Chip
Description	SMD, MLCC, Ultra-Stable, Low Loss, Class I
Features	Ultra-Stable, Low Loss, Class I
RoHS	Yes
Termination	Tin
Marking	No
AEC-Q200	No
Typical Component Weight	67 mg
Shelf Life	78 Weeks
MSL	1

Specifications

Capacitance	0.39 uF
Measurement Condition	1 kHz 1.0Vrms
Capacitance Tolerance	1%
Voltage DC	25 VDC
Dielectric Withstanding Voltage	62.5 VDC
Temperature Range	-55/+125°C
Temperature Coefficient	U2J
Capacitance Change with Reference to +25°C and 0 VDC Applied (TCC)	-750+/-120 ppm/C, 1kHz 1.0Vrms
Dissipation Factor	0.1% 1 kHz 1.0Vrms
Aging Rate	0.1% Loss/Decade Hour: Referee Time is 1000 Hours
Insulation Resistance	2.5641 GOhms

Statements of suitability for certain applications are based on our knowledge of typical operating conditions for such applications, but are not intended to constitute - and we specifically disclaim - any warranty concerning suitability for a specific customer application or use. This information is intended for use only by customers who have the requisite experience and capability to determine the correct products for their application. Any technical advice inferred from this information or otherwise provided by us with reference to the use of our products is given gratis, and we assume no obligation or liability for the advice given or results obtained.