

Double Faston

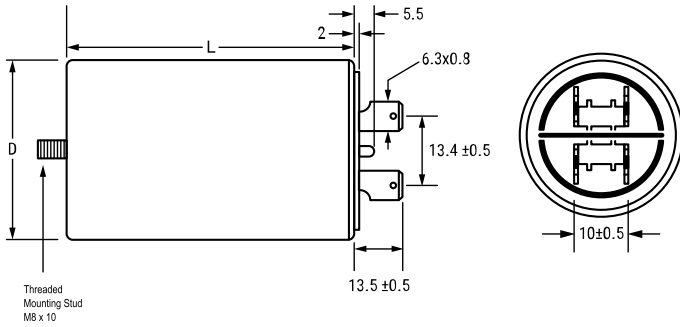

Click [here](#) for the 3D model.

General Information

Series	C27
Dielectric	Film/Foil Polypropylene
Style	Can
Description	Plastic Case and Cover, Ultra Sonically Welded Seal
Features	Ultra Sonically Welded Seal, Safety Class P0, UL_94 V0 Disk
RoHS	Yes
Lead	Fast On (2+2)
Qualifications	UL, VDE, UL (Construction Only), UL_94 V0 Disk
AEC-Q200	No
Typical Component Weight	112 g

Specifications

Capacitance	20 uF
Capacitance Tolerance	5%
Voltage AC	470 VAC
Temperature Range	-25/+85°C
Rated Temperature	85°C
Max dV/dt	20 V/us

Dimensions

D	45mm +1mm
L	74mm +/-2mm

Packaging Specifications

Terminal Type	Bolt-M8x37
Packaging	Bulk, Bag

Statements of suitability for certain applications are based on our knowledge of typical operating conditions for such applications, but are not intended to constitute - and we specifically disclaim - any warranty concerning suitability for a specific customer application or use. This Information is intended for use only by customers who have the requisite experience and capability to determine the correct products for their application. Any technical advice inferred from this Information or otherwise provided by us with reference to the use of our products is given gratis, and we assume no obligation or liability for the advice given or results obtained.